

# QUALITYGUIDE



QUALITY & FUNCTION

145 good reasons  
for choosing a  
nobilia kitchen

**nobilia**<sup>®</sup>

# QUALITY & FUNCTION



As you know, competent and effective customer service is essential to successful sales. This includes demonstrating sound product knowledge that goes beyond what is in the general sales documents, leaflets and image brochures. The QUALITYGUIDE companion in front of you is a comprehensive compendium of "145 Good Reasons" to enhance your customer service. The guidebook shows you the difference that the value of a nobilia kitchen makes: intelligent and useful design of the individual components in addition to sophisticated fittings and functional technology in superior quality! In addition, we also inform you about product tests such as preventive and series production-related tests in our QC test laboratory.



The following holds true for us, from the smallest detail to perfect packaging: only the best will do for our mutual customers. First-class kitchens that are produced using environmentally-friendly methods, that are documented through certifications for QualityManagement and Environmental Management, that are tested for safety and that use sustainable materials! From the quality to the distinctive features and characteristics of the different materials and surfaces to covering the planning specifics and special installation aids, we have compiled the most important information about nobilia in two motivational guides. In addition to the nobilia QUALITYGUIDE, our STYLEGUIDE covers the topic of planning and provides extensive informations about the nobilia kitchen system with its multifaceted and flexible planning possibilities. We hope you enjoy your reading.

THE CARCASE	4   5
UNIT FEATURES	6   7
PLINTH FEET   PLINTH PANELS	8   9
FITTING TECHNOLOGY   HINGED DOORS	10   11
DRAWER AND PULL-OUT SYSTEMS	12   13
CARCASE DÉCORS   FRONTS	14   15
WORKTOPS   UPRIGHT PANELS   CORNICE STRIPS   LIGHT PELMETS	16   17
SYSTEM GRID   DRAWER ORGANISERS	18   19
PULL-OUT ORGANISERS	20   21
INDIVIDUALISED COMFORT	22   23
CORNER UNITS	24   25
TALL UNITS   HIGHBOARDS	26   27
WALL UNITS   DRESSER UNITS   WALL SHELF	28   29
FLAP DOORS   FOLDING DOORS   SWIVEL FLAP DOORS	30   31
PACKING   INSTALLATION	32   33
QC TEST LABORATORY	34   45
CERTIFICATES	46   47

# THOROUGHLY WELL-MADE

Nobilia uses highly automated series production to manufacture more than 1300 units. The manufacturing base is the **dimension®** modular design with three base unit heights, five wall unit heights, four dresser unit heights and four tall unit heights.

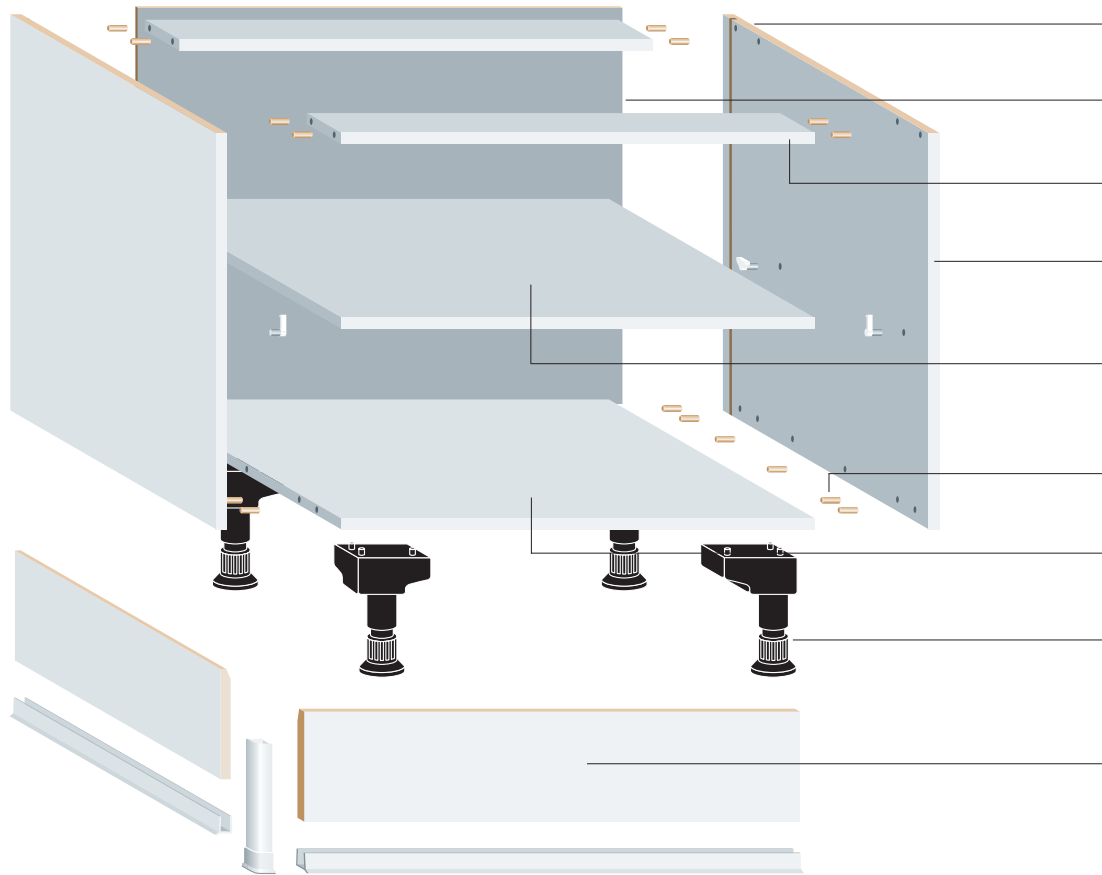

side panels 16 mm thick,  
both faces melamine direct coated

back panels 2.8 mm hardboard,  
screw mounted to carcass

crossbars 19 mm thick,  
both faces melamine direct coated

carcase front edges  
with PP thick edging (1.2 mm thick)

shelf, 16 mm thick,  
front edge with PP thick edging (1.2 mm thick)

shelf and side panels glued in  
with hardwood dowels (8 x 30 mm)

construction shelf 19 mm thick,  
both faces melamine direct coated

plinth feet with height adjustment  
-10 and + 20 mm

plinth panels made of MDF  
70 mm, 100 mm, 150 mm, 200 mm  
13 mm thick, direct coated

## 1 CARCASE MATERIAL 16 MM

Side panels 16 mm thick,  
both faces melamine direct  
coated – thus, extremely  
durable and easy-care.



## 6 SHELVES 16 MM ANTI-TIP DEVICE

Shelves have PVC-wrapped  
metal shelf supports with  
shelf locking devices for  
lasting anti-tip protection.  
This guards against accidental  
pulling out and pushing  
upward of the shelves (child  
safetyguard).



Minimises complaints



load capacity



Easy mounting



Great value

2 FRONT EDGE OF CARCASE/ SHELVES

Carcase front edge and shelves coated with PP thick edging 1.2 mm. Extremely resilient and impact resistant. Attractive appearance due to soft rounding.

3 CONSTRUCTION SHELF CROSSBARS 19MM

Extremely sturdy construction shelves and crossbars for base and tall units. Top crossbars for base units: white edge colour for uniform appearance.

MOISTURE DOESN'T STAND A CHANCE HERE

Edges on shelves and side panels sealed all round to ensure a clean finish and prevent penetration of dirt and moisture.



5 HARDWOOD DOWELS 8X30 MM

Shelves, construction shelves and side panels are glued in with hardwood dowels.



The high quality construction of the carcase elements in addition to the well-thought out fittings technology is the result of many years of experience and continual process improvements in the production flow.

Bernd Heldt, Employee Product Development/ Prototyping



7 GLASS SHELVES

Glass wall units come standard with a 5 mm glass shelf for a uniform, transparent appearance. Units with swivel flap doors and folding-lifting doors have 6 mm thick glass shelves.

8 50 KG PER QM SHELF LOAD CAPACITY

It All Fits! All shelves (including loose shelves) have a load capacity of up to 50 kg/qm. This is equivalent, for example, to over 80 dinner plates.



9 REAR PANELS OFFSET TOWARD FRONT

2.8MM THICK 2.8 mm hardboard, interior in décor, lacquered or imprinted. Rear panels rest in 4 to 6 mm deep grooved side panels and are also screw mounted to the carcase. The rear panels are offset toward the front to ensure good air circulation between the wall and kitchen furniture and won't



get wet. This prevents the formation of mold and mildew. Advantage: no interior gap formation visible. Long-lasting, permanently sturdy, yet variable for the fitter on site.



## IT'S WHAT IS INSIDE THAT COUNTS!

560 MM  
522 MM

### 10 IT ALL FITS!

- Carcase depth for base and tall units: 560 mm.
- Useable depth: 522 mm.
- Maintenance-free fittings/easy-to-assemble.

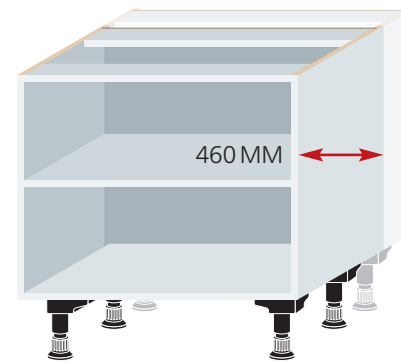

### 11 SIDE DEPTH 460 MM WITHOUT SURCHARGE

The side depth of 460 mm provides planning reliability for planning of narrow room layouts without surcharges for custom productions.



### 12 MOISTURE PROTECTION SHELF

Optional: the moisture protection shelf for sink base units and for units with special requirements, for instance appliance units, prevents scratching of the bottom shelf by vacuum cleaners and other devices. Residual moisture protection for cleaning buckets, brooms or cleaning materials.



### 13 STURDY METAL CROSSBARS

Cookerhousing units, sink units or corner carousel units are provided with remarkable stability due to the integrated metal crossbars.



The quality of kitchen components is not usually in the foreground, but rather concealed in the interior, and yet it is so important. This holds true for metal crossbars, protection panels and metal shelves that lend the design stability and durability.

Andreas Bielefeld,  
Director of Product Management



14 FULLY UTILISABLE

The metal grid in sink pull-out units can be freely positioned. Thus, a recess for the odour trap is not necessary and the pull-out can be fully utilised.



15 HEAT PROTECTION SHIELD COOKER/OVEN

Here, the heat doesn't stand a chance: all cooker and oven housings come standard with a heat protection shield.



16 STEAM PROTECTION PLATE DISHWASHERS

Tall units for raised dishwashers come standard with an extra deep steam protection plate.



17 STEAM PROTECTION PLATE WALL UNITS

Here, the heat doesn't stand a chance: optional steam protection plate for wall units adjacent to the cooker hood (DDS/4502).



18 CORNER BASE UNITS CAN BE DISASSEMBLED

Corner base units can be disassembled on site (i.e. UEK 90). This allows them to fit through even tight stairwells and narrow doors.



## THE PLINTH – STEADY !



PLINTH ADAPTER

200 MM

150 MM

100 MM

70 MM

ADAPTER FOR INTERMEDIATE SIZES



### 19 4 STANDARD-PLINTH HEIGHTS

- The sturdy plinth construction with adapters and feet comes in the standard heights 70, 100, 150 and 200 mm.
- Adjustable range from -10 to +20 mm.
- Deviating plinth heights in intermediate sizes (10 mm grid) possible with adapter. (Chapter 3, order no. 4187)

- Plinth feet independently adjustable. Ideal for uneven tiled floors, as the unit always stands straight!
- Load capacity: 250 kg per unit /4 feet.

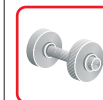

Can accommodate granite worktops.



### 20 SIDE PLINTH PANEL 50 MM ADDED

The fitters will be happy: By adding another 50 mm to side plinth panels the fitter can adjust the panel on site.





21 | PLINTH PANELS 13 MM

Plinth panels are produced from 13 mm MDF (= medium density fibreboard) and are direct coated. This makes them extremely resilient and easy care.



22 | FLEXIBLES FLOOR SEALING PROFILE

The floor sealing profile adapts even to uneven tiled floors, creating a clean finish and preventing penetration of moisture and dirt into the plinth interior.



23 | ADDITIONAL DELIVERY PLINTH PANEL

With every commission we supply an additional 2300 mm long plinth panel and return. This aids in preventing complaints and can be used as reserve material for on site adjustment or as panel material.



24 | WATERPROOF PLINTH PANEL

Waterproof plinth panels foil-coated in stainless steel finish are available for a surcharge. They are useful everywhere where it is particularly humid and damp, and they look great as well.

25 | BETTER SAFE THAN SORRY

These plinth feet solutions provide anti-tip installation of free-standing kitchen runs or islands.



26 | LIGHTWEIGHT AND AIRY – OPEN PLINTH SYSTEMS

In conjunction with 25 mm thick upright panels different plinth feet can be used for elements. All feet can be individually height adjusted.

27 | TERRIFIC EFFECT – PLINTH LIGHTING

This is how to highlight plinths: with the LED plinth light that can be individually mounted or with the Flex LED flexible light tape.

# ROBUST, PERFECT, LONG-LASTING!



## 28 3D-QUICK MOUNTING HINGES

The superior quality fittings are all metal, robust, long-lasting and hold hinged doors in the perfect position for years. The hinges have an automatic locking feature for opening and closing through an integrated spring mechanism. All hinges provide comfortable access to the unit interiors.



## 29 110°-HINGE FOR HINGED DOORS

The 110°-hinge as well as all special hinges are three-dimensionally adjustable and possess a clip lock for tool-less assembly and disassembly.



## 30 170°-HINGE FOR CORNER WALL UNITS

Corner wall units are equipped at the factory with 170°-hinges. This enables comfortable access even in hard-to-reach corners.

## 31 95°-HINGE FOR DIAGONAL CORNER UNITS

95°-hinges are used in diagonal corner units. The limited opening angle prevents contact with the door handle of the adjacent unit.



**32** DOOR HINGE BUFFER

All fronts come standard with 2 mm thick plastic cushioning stops fitted to the interior face. For even more quiet closure, special cushioning is optionally available.



**33** DOOR CUSHIONING FOR HINGED DOORS

The optimum cushioning for hinged doors is mounted directly to the interior face of the door and can be retrofitted at any time.



Loudly closing doors are a thing of the past. For corner wall units and glass framed doors the cushion is screw-mounted under the top shelf.



**34** 85° – OPENING ANGLE LIMITER

The opening angle limiter on 110° hinges ensures safety when planning corner solutions, wall unit attachments and glass doors adjacent to the cooker hood. The limited angle also prevents contact between handles on corner units.



**35** PUSH-TO-OPEN SYSTEM

For handleless planned kitchens, hinged doors can also optionally be equipped with the push-to-open system. The system can be retrofitted at any time.



## THE PULL-OUT WITH THE SHHHHH...

### 36 METALLIC STEEL FRAME

The metallic steel frame is double layer powder-coated in silver colour and additionally given a clear varnish finish, making it extremely scratch-resistant. The bottom is 16 mm thick.

### 37 TANDEM QUADRO BALL BEARING RAIL

Long service life due to precision steel bearings. The quadro ball bearing runners require no further care. The ball bearing principle ensures that the runners are self-cleaning.

### 38 HIGH SYSTEM LOAD CAPACITY

High system load capacity up to 30 kg, for 800/900 mm width up to 50 kg, for 1000 mm up to 65 kg.

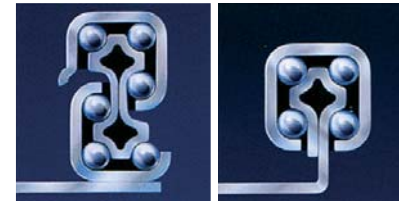

### 40 TOOL-LESS ADJUSTMENT

Millimetre precise, tool-less height and width adjustment. Retains optimum operating properties and reliability even after many years of use.



### 41 JOINT PATTERN

Front panels with adjustable height, slope and sides ensure uniform joint patterns.

### 42 EASY-TO-CLEAN

Particularly easy-to-clean due to flush-surface integrated soft edges in the drawers.

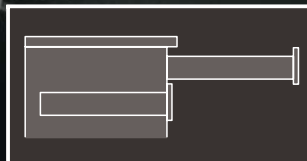

## 39 CUSHIONING "SILENT-SYSTEM" BY HETTICH

Super comfort for silent closure. With pneumatic cushioning, drawers glide gently and quietly shut. In the last stage of the closing process the motion decelerates similar to a slow-motion effect.

The drawer closes silently. Thus, shifting contents (cutlery) create less noise.



With premium pull-out technology, nobilia's kitchens have base units equipped with full pull-outs, so they are easily accessible even in the furthest corners. All drawers, front pull-outs and internal pull-outs form a harmonious unit with a Silver-grey metallic steel frame as full pull-out including the integrated Quadro ball bearing rail. The Classic system with partial pull-out technology is also available as an alternative.



## 43 GLASS SIDE PANELLING

Optionally available: Glass side panelling for pull-outs. For an elegant side view.

## 44 ANTI-SLIP MAT

Optionally available for all drawers and front pull-outs. Advantage: the bottoms are protected for a long service life and the contents shift less without the need for expensive interior organiser systems.



## 45 MORE CONVENIENT INSTALLATION AND REMOVAL

Due to the quick mounting and removal, Premium drawers are very fitter-friendly, easy-to-clean and suitable for relocating.



## 46 DRAWERS PARTIAL PULL-OUTS CLASSIC

The Classic pull-out technology offers the economical version: here, the drawers and pull-outs are provided with a silver-grey metallic steel frame with partial pull-outs and integrated Tandem-Quadro ball bearing rails.

Entry price level solution top quality.



# WHAT TYPE OF WOOD IS MY KITCHEN MADE FROM?

## 47 CARCASE DÉCORS – CLEANLINESS FIRST

- Interior carcase colour: standard = White.
- Bright interior: good overview, everything is easier to find.
- End customers connect White with factors such as hygiene, cleanliness, health.
- Exterior carcase colour: Freely selectable in 16 trendy carcase colours.

- Glass wall units or shelves are available in carcase décor on both faces (interior as well as exterior) without a surcharge. Thus, there is no visible side specification necessary.
- No surcharge for exterior décors. And with a later relocation, all units can be repositioned – no visible sideproblematic.

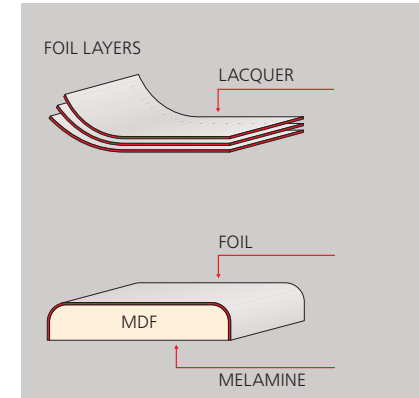
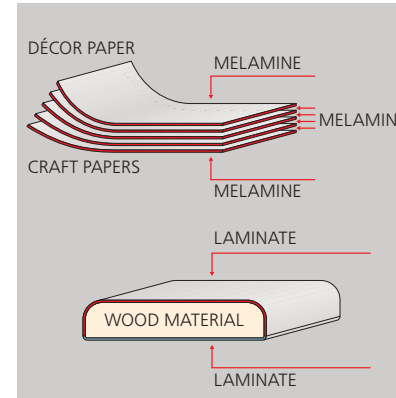
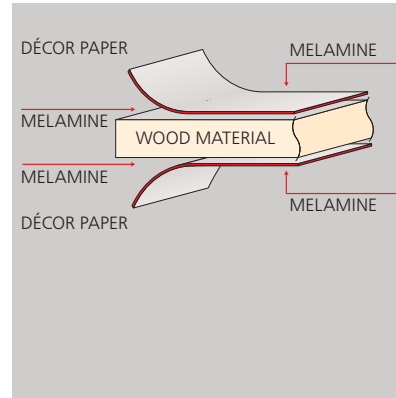

## 48 MELAMINE DIRECT COATED

- Optimal for kitchen furniture.
- Extremely resilient.
- Surfaces could contain fine textures which only enhance the beautiful wood reproduction appearance.
- Easy-care.
- Affordable.

## 49 MELAMINE RESIN LAMINATE

- For seamless fronts with vertically rounded edges.
- For horizontally rounded worktops.
- Extremely resilient.
- The surface is multi-layered and therefore thicker than the melamine front.
- Sturdier than the melamine fronts.

## 50 FOIL-COATED FRONT

- Seamless rounding on all sides possible.
- Extremely resilient.
- Also ideal as a framed front, seamless front face.
- An attractive alternative to genuine wood or lacquer.
- Outstanding value formoney.



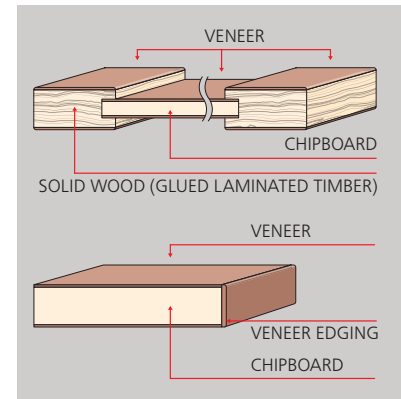
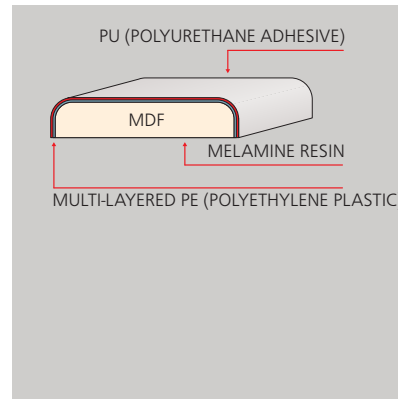
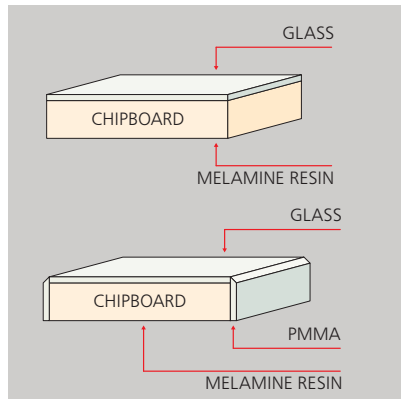
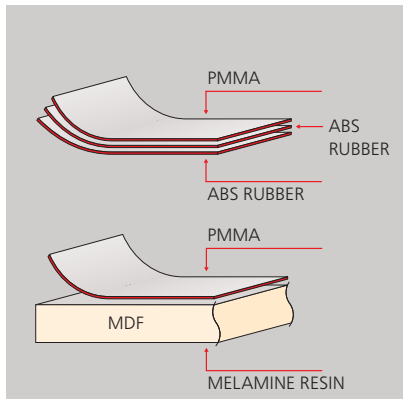

QUALITY FOR ALL PRICE GROUPS

State-of-the-art processing technologies and the highest quality materials speak in favour of the entire spectrum of nobilia fronts and carcasses. Here, we will show you the characteristics and advantages of the selected materials.

51 ACRYLIC FRONTS

- Shine and depth of gloss unequalled in glass reproduction.
- The look of real glass only more lightweight and more affordable.
- Ample strength, shatter-proof.
- Unrivalled for metallic effects.
- Easy-care - simply treat scratches with polish.

52 GLASS FRONTS

- Exquisite degree of shine, for a look that is unsurpassed.
- Optimal for kitchen furniture.
- Resistant, easy to clean.
- Upper price segment.

53 LACQUER FRONTS

- High gloss lacquer is pure luxury.
- Seamless front face.
- Durable, easy to clean.
- Honed lacquer with slight texture, for better scratch-resistance.

54 GENUINE WOOD FRONTS – A VALUABLE PIECE OF NATURE

- Every front is unique and never absolutely identical.
- Frame, glued Solid wood (glued laminated timber), both faces veneered.
- Infill panels, drawer front panels in solid wood veneered.

MDF = Medium density fibreboard.  
PMMA = Polymethyl methacrylate/Acrylic.

- Upright panels, veneered chipboard, front edge with veneer edging.
- Fronts and upright panels uniformly stained, acrylic primer and open-pore acrylic top coat.
- Upper price segment.

## OUR WORKTOP IS THE TOUGHEST!



- nobilia worktops are distinguished by outstanding functional value.
- The substrate of the 39 mm thick worktop is high quality 3-layer chipboard.
  - They are coated with hard-wearing plastic laminate panels (HPL high pressure laminate and CPL continuously pressured laminate surfaces).
  - The thickness of the laminate measures 0.6 to 0.8 mm.
  - Lateral cut edges are provided with décor edging.
  - Useable depth: Standard 600 mm / up to max. 1170 mm. 1200 mm for N edge.
  - Butted glued joints are ensured with waterproof D3 glue (PVAC - polyvinyl acetate glue).



### 57 NEDGE

The panel is laminated around the rounded front edges. The sides can be finished with 1.5 mm thick décor edging or inset N edge (for a surcharge). For optimum protection against moisture the N edge is sealed over the transition to the bottom face.

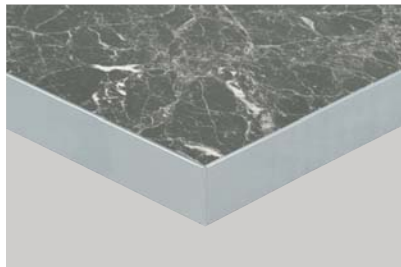

### 58 DÉCOR EDGE

Décor edges are 1.5 mm thick PP plasticclippings available in all worktop décors. The PP edging is glued with waterproof PUR adhesive. PP front edges enable individualised freeform surfaces for worktops, tables and breakfast bar attachments.



### 59 ACRYLIC EDGE

The worktop front and side edges are provided with a 1.5 mm thick, high gloss acrylic edging. Acrylic edging designs: black, white, champagne, glass finish and silver.



### 60 THE SURFACE: SUPER TOUGH!

Worktop surfaces demonstrate a high degree of resistance to scratching and abrasion in accordance with DIN standard 68930. This is to ensure that the worktops can withstand the wear associated with conventional household use.



55 WORKTOPS  
SEALING TAPE

All nobilia worktops are also supplied with a 9 metre long sealing tape for worktop cut-outs and for insulation of the worktop above ovens and dishwashers. Other conventional sealing materials are unnecessary for installation.

This seal is quicker, cleaner and more secure.



61 WELL PROTECTED: AGAINST  
MOISTURE AND HEAT!

The bottom face of the worktop is surfaced with a water repellent, resin impregnated paper and has a moisture protection seal along the rear edge. Heat resistant up to 180°C with dry heat and up to 100°C with moist heat (DIN 68930).

62 WORKTOP  
SLIM LINE 16 MM

Slim Line is made from a high quality laminate panel coated on both faces. Laminate thickness: 0.6 to 0.8 mm. Increased functional value with HPL and CPL surfaces. Décor or acrylic edging all round in 1.5 mm.

63 UPRIGHT PANEL SYSTEMS: 57 DÉCORS  
3 LACQUER VERSIONS/ 2 GENUINE WOOD VERSIONS

Material thicknesses: 16, 25 and 50 mm wide. Direct coating using melamine resin or acrylic coating. 5 Décor Groups: Matt (carcase colour), High gloss, Ultra-High gloss, Worktop décors, Slim Line upright panels.

Slim Line upright panels can also be finished like Slim Line worktops with an acrylic edging allround.

56 CORNICE STRIPS | LIGHT  
PELMETS SECURITY DURING  
TRANSPORT

The outer corners of cornice strips are factory glued, completely enfolded in cardboard and securely fastened. For transport safety, the cornice strips are also secured in place on the support cardboard using wood blocks.



Light pelmets are secured to the support cardboard during transport with plastic packaging bands. For more information about safe and secure packing, refer to page 33.



MODERN 4 STAGEGRID



TRADITIONAL 5 STAGEGRID



64 VARIOUS  
DRAWER HEIGHTS

Optimum use of storage space, from your cutlery to your large asparagus cooking pot.

- 141 mm high drawer.
- 177 mm high drawer.

Ideal for use as a mini pantry, fits 425 ml or 850 ml food tins.

- 285 mm high pull-out with 144 mm high back panel.
- 357 mm high pull-out with 176 mm high back panel.



Versatile organiser systems for drawers and pull-outs offer structured storage for everything you want to accommodate in the kitchen. From cutlery, cling wrap and spices to baking trays and even entire beverage crates. Variable designs, easy-care plastic, sophisticated solid wood or a combination of both. With fixed or variable division possibilities – the perfect solution for every need!



## 65 CUTLERY TRAYS

A large selection of cutlery trays made of plastic or wood provides the very best drawer organisation.

Fits all drawer widths from 300 mm to 1000 mm with 560 mm side depth.

Several cutlerytrays are available for a side depth of 460 mm.

## 66 FULL PULL-OUT/ UNIVERSAL ORGANISER

- Wood or plastic.
- Unit widths: 600, 800, 900 and 1000 mm.

- Full pull-out load capacity up to 30 kg, for 600 mm width, up to 50 kg, for 800/900 mm width and up to 65 kg for 1000 mm width.





THIS CALLS FOR ORDER!



**67** FULL PULL-OUT 15 CM  
2 METAL BASKETS

In a narrow space of just 15 cm, next to the cooker or hot plate, for instance, everything you need is at hand. Perfect for storing oil and vinegar or spices.



■ Load capacity per shelf 6 kg.



**68** FULL PULL-OUT 15 CM  
BAKING TRAY HOLDER

Finally, a clever solution for stowing those countless baking trays and grids.



**69** FULL PULL-OUT 30 CM  
INTERNAL PULL-OUT

An interesting solution that won't dissect your front grids. It looks like a door, but provides ingenious and ergonomic organisation possibilities.

■ Load capacity per shelf 30 kg.



A successful kitchen sale depends in large part on the clarity of the systematic offered in the kitchen range. We can offer our customers practical solutions specifically designed for their individual needs, especially in the area of pull-out organisation.

Cathrin Freihof,  
Kitchen Planner in the Creative Studio



**70** FULL PULL-OUT 30 CM METAL BOTTLE RACK

A great invention: The bottle rack is directly accessible and even removable.



**71** WASTE SEPARATION SYSTEMS

You will also find a large selection of waste systems for sink units. For further information please refer to the Sales Manual.



**72** LARGE CAPACITY PULL-OUT

The large capacity pull-out with the 80 and 90 widths maximises storage space by making use of the otherwise empty space in the plinth area. This opens up enough space to store even beverage crates. And that saves many a wearisome trip to the cellar.



**73** CARGO PLINTH

Just like the large capacity pull-out, the Cargo plinth also makes use of the empty space in the plinth area for maximum storage. This leaves enough room for a "full scale" wasteseparation system in a minimum of space.

## INDIVIDUALISED COMFORT



For kitchens with diverse floor plans, from the small to the very large, the nobilia kitchen system helps you find the right answers for effectively planning your kitchen space.

For instance, optimising storage space with the plinth drawer and additional internal drawers, the concealed pull-out table in the base unit or the shapely Z solution for end of run units when space starts to get tight in the kitchen.



### 74 END OF RUN UNIT Z SHAPE

For a gentle transition into the room's free space or for better access to adjacent doors, the Z-shaped end of run unit is ideal. Not to mention that the perfect Z shape also creates an optimum seamless appearance.



### 75 APPLIANCES ALL-PURPOSE SLICER

The accessories range offers an electric all-purpose slicer for drawer widths starting at 450 mm. The all-purpose slicer can simply be folded away into the drawer for space-saving storage.

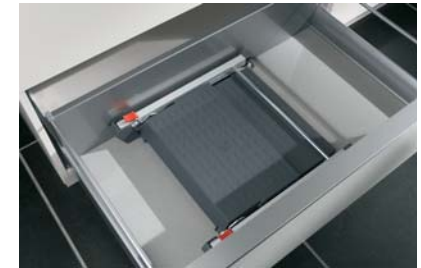

### 76 FOLD-OUT STEPLADDER

The aluminium fold-out stepladder can easily be stored in a drawer or hung on an integrated universal holder. For mounting in base and tall units.



## 77 PLINTH DRAWER

The remarkably practical plinth drawer maximises storage space by utilising the "dead space" beneath the plinth. It is available in the widths 400, 450, 500, 600, 800, 900 and 1000 mm.



## 78 INTERNAL PULL-OUTS

Additional internal drawers can be planned for front pull-out units and hinged door units. They can also be retrofitted at a later date.

Many units from the wide range of products already come standard equipped with internal pull-outs.



## 79 PULL-OUT TABLE

Especially for small kitchens The base unit element with pull-out table represents a space-saving solution for a "mini dining area". This unit is available in the widths 500 and 600 mm in each of 2 table heights: 710 or 850 mm table height for a plinth height of 150 mm.

## THERE IS SPACE IN EVEN THE TINIEST CORNER

With nobilia corner units you have absolute planning security thanks to alternative dimensions, customised comfort options and super storage space access.

- Planning dimensions for corners without storage space: 650 x 650 mm (angle filler for "dead corner").
- Planning dimensions for corner unit: 800 x 800 mm, 900 x 900 mm.
- Planning dimensions for diagonal corner unit: 800 x 800 mm, 900 x 900 mm.
- Planning dimensions for half corner base units: 650 mm x 1050-1120 mm, 650 mm x 1100-1170 mm, 650 mm x 1150-1220 mm, 650 mm x 1250-1320 mm.



### 80 ANGLE FILLER UPE\* "DEAD CORNER"

- Affordable.
- The corner solution with an angle filler offers no storage space.



### 81 CORNER BASE UNIT U(D)TE\* WITH SHELVES

- Price-oriented storage solution.
- Easy access due to 170° hinge.
- Can be disassembled on site.
- Load capacity per shelf up to 50 kg/qm.

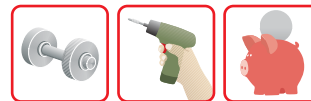

### 82 CORNER WALL UNIT WE\* WITH SHELVES

- Easy access due to 170° hinge.
- Maximum load capacity 75 kg.
- Load capacity per shelf 16 kg.
- Optimum design continuity with the corner base unit.



### 83 CAROUSEL CORNER UNIT UE(D)K\*, 360°

- Mid-priced segment.
- Intermediate level operating comfort.
- Clear overview thanks to rotary shelves.
- Can be disassembled on site.
- 3D Front adjustment.
- Adjustable closing force.
- Load capacity per shelf: 25 kg.

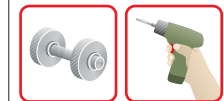

● Storage space solution with intermediate ...





### 84 DIAGONAL CORNER UNIT UED(D)\*

- Diagonal corner solution with shelves.
- Price-oriented storage solution.
- Can be disassembled on site.
- Load capacity per shelf up to 50 kg/qm.

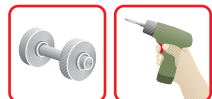

### 85 DIAGONAL CAROUSEL UNIT UED(D)T\*

- Rotary carousel with wooden shelves and metal railing offers a clear overview of contents.
- Mid-priced segment.
- Storage space solution with intermediate level operating comfort.
- Rotates 360°.



- Can be disassembled on site.

### 86 HALF CORNER UNIT UE(D)\*

- Diagonal corner solution with shelves.
- Price-oriented storage solution.
- Load capacity per shelf up to 50 kg/qm.



### 87 HALF CORNER UNIT UEBD\* SEMI-CIRCLE ROTARY SHELVES

- Mid-priced segment.
- Half corner unit with wooden shelves and metal railing offers a clear overview of contents.
- Storage space solution with intermediate level operating comfort.
- Load capacity per shelf: 15 kg.

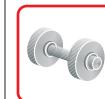

### 88 HALF CORNER UNIT UE(D)SA\* SWIVEL PULL-OUT

- High-end segment.
- Swivel tablars meet the user half way - easier access to the interior.
- Excellent use of unit interior through the tablar.
- Storage space solution with high operating comfort.

← 560 MM →

← 522 MM →



- Carcase depth for base and tall units: 560 mm.
- Useable depth: 522 mm.

3D-Quick mount hinge, maintenance-free, easy-to-mount.

Shelves, 16 mm with anti-tip protection.

Back panels, 2.8 mm hardboard in grooved sides, screw mounted to carcase.

Construction shelf, 19 mm with side firmly affixed with dowels.

Premium pull-out technology for crockery units, pantry units, appliance housings.

IT ALL FITS !

## 89 APPLIANCE AND PANTRY UNIT

The universal unit in the truest sense of the word. With various internal divisions, pull-outs and drawers.



## 91 PANTRY UNIT DUOPORT

In the Duoport pantry unit the interior is linked to the door. When the door is opened, the hanging baskets float towards you.



## 92 BROOM AND APPLIANCE UNIT

Everything you want, everything you need: System grids, cleaning materials basket, systematic shelves, peg boards, hose holder for vacuum cleaner.

## 90 LARDER UNIT

The larder unit is equipped with a high quality full pull-out and pneumatic cushioning. The hanging baskets are available in three different designs:



As Classic equipment:

- Wire hanging basket.

As Premium equipment:

- Hanging baskets with wooden shelf and metal railing.

- Hanging basket with wooden shelf and glass side, for a surcharge.

Maximum load capacity is 80 kg.



89

90

91

92

← 320 MM →  
← 300 MM →



## THE RIGHT SOLUTION FOR ALL WALLS

The wall unit mounting system guarantees secure mounting in honeycomb brick, sand-lime brick and concrete. Spacer panels are for compensating wall protrusions, for instance with tile, and are included in the scope of delivery. Freely suspended wall units can be provided with an anti-tip device on site to prevent lateral shifting. For maximum safety the anti-tip device is automatically and free-of-charge confirmed.



- Carcase depth for base and tall units: 320 mm.
- Useable depth: 300 mm.

3D-Quick mount hinge, maintenance-free, fitter-friendly.

Shelves, 16 mm with anti-tip protection.

Back panels, 2.8 mm hardboard in grooved sides, screw mounted to carcase.

Construction shelf, 16 mm with side firmly affixed with dowels.



### 93 THE COMPLETE PACKAGE

The fixing rails are included in the scope of delivery for wall units. Upwards of 590 mm width requires 4 screws and dowels for maximum safety.



### 94 COVER CAPS STANDARD

Metal coloured cover caps come standard with all wall units.

97 LIGHTED PANELS

Lighted panels in wall units serve two purposes. They create a uniform work station and unit interior lighting. They are supplied with integrated switch, cable and Euro plug.



95 MAXIMUM LOAD CAPACITY

The maximum load capacity for wall units is 75 kg.  
 ■ Load capacity per shelf 16 kg.



96 GLASS SHELVES

All wall units with glass fronts come standard with 5 mm thick glass shelves. Units with swivel flap doors and folding-lifting doors have 6 mm thick glass shelves.

98 ROLL-UP FRONTS AND DRESSER UNITS

Roll-up front dresser units offer the advantage that small appliances are always at hand in the niche with socket and after use can be quickly stowed away again.

- Comes standard with triple socket (dependent upon country) for roll-up front dresser units.
- Standard with 10 watt halogen spotlight for glass roll-up front dresser units.



99 WALL SHELVES

Can be used everywhere. An affordable solution to create storage shelves as well as highlight with accent decorations.  
 ■ Shelf support load capacity per pair 12 kg.

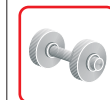

## FLAP DOORS, FOLDING DOORS, SWIVEL FLAP DOORS!

The alternative to hinged door units are wall units with swivel flap doors, flap doors or folding doors. The advantages are clear: these reduce the door opening angle and are not in the way in smaller kitchens. Also, headroom is also guaranteed with every unit. High quality fittings technology guarantees that the flap doors stay put where you want them.



### 100 FLAPS

Flap lifting fitting with 100° opening angle and integrated soft closure for wall units in 325.5 mm and 359 mm height. The door remains in whatever position you want it.  
Unit widths:  
450, 500, 600, 800, 900 mm.

### 101 FOLDING-LIFTING DOORS

For space-saving opening of flap door wall units. The door remains in whatever position you want it. The closing force is individually adjustable, the hinge cushioned.  
Unit widths:  
500, 600, 800, 900 mm.



102 SWIVEL FLAP DOORS

For space-saving swivelling of the front above the carcass. The hinge is cushioned. Unit widths: 500, 600, 800, 900 mm.

103 FOLDING-SLIDING DOORS

Works well in narrowly fitted kitchens, because the opening angle of the door is cut in half. The folding-sliding door functions via sliding technology on the top shelf. Only for 600 mm wide wall units.

104 PACKING CARCASE COMPONENTS

- Sides and front are completely covered with cardboard.
- Nylon belts (for strapping).



108 HARD PLASTIC CORNERS

Hard plastic corners are used on the rear bottom carcase side of tall units for extra protection. This prevents damage due to standing on end.

105 CORNER PROTECTION

Corner units are additionally equipped with a self-adhesive corner sleeve, to protect them from damage during transport.



109 PACKING CORNER CAROUSEL UNITS

Corner carousel units have a cardboard cover with clearly defined gripping positions. This simplifies transport.

106 PACKING WORKTOPS

Worktops are packed in foil and reinforced with cardboard corners, in part also with fibreboard supports.



110 TRANSPORT CROSSBARS

Appliance housings with high appliance cut-outs are secured during transport by a transport crossbar. This provides additional stability as long as the appliance is not installed.



107 PACKING PLINTH STRIPS

Plinth strips are packed with cardboard protectors and wrapped with straps at the package ends.



111 PROTECTIVE FOIL

Fronts with sensitive finishes, for example high gloss fronts, are protected during production and installation with a special protective foil.



112 UNITS PRE-ASSEMBLED

All units and interior equipment are delivered fully assembled. This saves installation time and everyone's nerves.





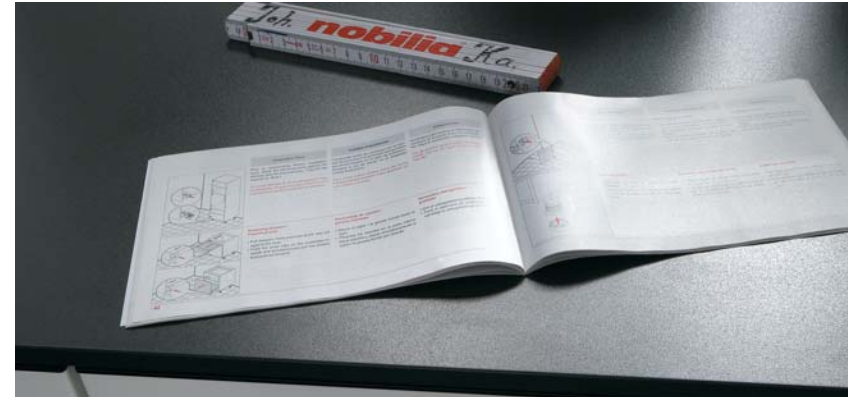

**113** INSTALLATION-FRIENDLY SYSTEM

The nobilia kitchen system is characterised by its absolute ease of installation. Beginning with corner units that can be disassembled

to get through narrow stairwells to the fine adjustment of the plinth and fronts, and to the quick mount hinges for doors.



**114** INSTALLATION INSTRUCTIONS

For all installation procedures you will find detailed installation instructions for every commission and of course also at our web page: [www.nobilial.de/#/Kitchen Planning/ Installation Instructions](http://www.nobilial.de/#/Kitchen%20Planning/Installation%20Instructions)



# RESPONSIBILITY TO EXCELLENCE: QUALITY ACCORDING TO QC STANDARDS

## NOBILIA QUALITY MANAGEMENT

Quality objectives at nobilia are defined company-wide. The quality management is preventively and consistently in place covering the entire process chain. From the preliminary supplier to the final installation of the nobilia kitchen at the end customer's premises - nobilia's quality management has the continual improvement of the entire process in focus. With this holistic approach nobilia has maintained their position as quality leader in the industry over many years. The guidelines for quality and environmental management are deep-seated in the company philosophy and the corporate culture at nobilia. For production this means: mistakes in production must be prevented, defective products are not to leave the factories at all. All quality assurance measures and quality tests at nobilia pervade all departments in the company and serve to prevent, analyze and correct mistakes.

## 115 TOP FIT FOR EVERYDAY USE

Nobilia kitchens are up to the challenge of daily use; all products have already proven their worth in nobilia's QC test laboratory.



## 116 THE "GLASS" LABORATORY

The significant effort that nobilia invests in the QC test laboratory prior to production start is now also visible to the customer. A new "glass laboratory" has been incorporated into the nobilia in-house exhibition and is of course, visible.

The 230 qm area allows visitors to gain insight into the comprehensive testing methods that the new products at nobilia must undergo and pass prior to being considered ready for production.



## 117 PRODUCTION- ACCOMPANYING TESTS

In order to ensure a consistently uniform series-production quality, the current series is monitored. This means that in predetermined intervals, production-accompanying tests are performed on the furniture or individual components.

The laboratory equipment is unique for a furniture manufacturer: nobilia can and does perform all their own compulsory tests meeting DIN standards and DGM (German furniture quality seal) requirements.

118 QUALIFIED EMPLOYEES

A quality management team of 16 ensure that the nobilia quality standards, which exceed both the national and international standards, are met in the areas of customer service, supplier management,

goods received, in-production inspection and test laboratory. Thereby, nobilia strictly and consistently addresses the requirements and the needs/wants of the trade and the end customer.

Only furniture that has passed the qualification tests in the nobilia test laboratory are accepted into the new collection. In this manner, nobilia customers are guaranteed that all new features/products meet the same high nobilia level of quality to which they are accustomed.

Frank Diestel,  
Director of Quality Management



119 SERVICE LIFE AT LEAST 15 YEARS

Customer suggestions and requests as well as practical experience and the results of our own studies are an ongoing and essential part of the development process. All the materials we use are tested for a minimum operating life of 15 years.

120 ONLY FULLY DEVELOPED PRODUCTS ON THE MARKET

New developments are subjected to extensive testing in the laboratory before they ever make it to series-production. Only fully developed products that have successfully passed all the tests are integrated into the nobilia collection.



## ROBOTIC TEST STATION

DAILY KITCHEN ROUTINES UNDERGO ENDURANCE TESTING!

Our robot is an all-round talent. He can be programmed so that his functions and movements correspond to the real work actions in a kitchen. Such as, opening and shutting the swivel flap doors and folding doors, opening and shutting the full pull-out, opening and shutting the hinged doors. A total of 15 years of daily kitchen wear is simulated here in real terms.



121 15 YEARS  
IN TWO DAYS

Doors and pull-outs are subjected to at least 60,000 opening and closing cycles. This wear and tear basically fast-forwards the service life of at least 15 years of daily kitchen wear.



## STATIC LOAD

There are guidelines for virtually everything. Our entire lives are for the most part regulated by standards. Though at times this can be confusing, it is however, helpful when you are dealing with the sturdiness, longevity and safety of kitchen furniture. Exactly what kitchen furniture must withstand is specified in the respective DIN standards. For maximum safety and in consideration of a long service life, nobilia's self-imposed standards often far exceed what is required. In the laboratory we continually test the load bearing capacity of top and bottom shelves and loose shelves on the load-bearing wall.



## 122

75 KG BEARING LOAD  
PER WALL UNIT

The wall suspension and wall unit construction are designed to hold 75 kg. This is far more than conventional tableware weighs: An 18 piece coffee set made of porcelain, for

instance, has an average weight of roughly 5 kg. Put another way, we are talking about the weight of a coffee set that would serve 90 people.

IN GREAT DEMAND...

We test hinged doors, pull-outs and larder units – in short, all moving components, in continuous operation for a total life-span of more than 15 years and – for us indispensable – and always with full capacity. In the process, we put stress and strain on our furniture in the QC laboratory, at times, up to three times longer than required by the DIN standards.



123 LARDER UNIT

- 60,000 – 80,000 load changes depending on load.
- This equates to approx. 11 to 15 times the amount of opening and closing performed in a day.

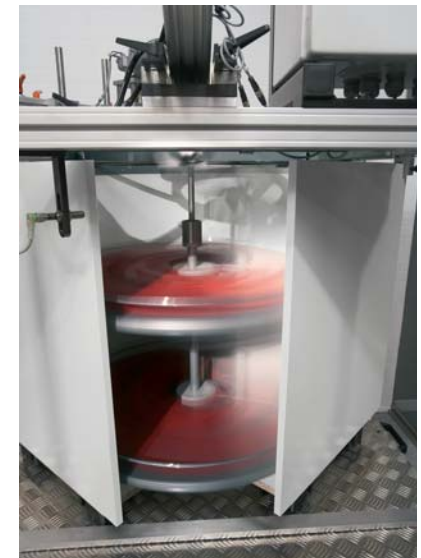

124 CAROUSEL CORNER UNIT

- 60,000 load cycles.
- This equates to approx. 11 times the amount of opening and closing performed in a day.

Morning, noon and night - there is always action in my kitchen. Doors open, doors closed, food supplies stored in the larder unit, cutlery put away and pulled out -our kitchen doors and pull-outs have to stand up to a lot. It is certainly beneficial to have a quality kitchen that has been tested in the manufacturer's own laboratory for virtually everything.

Volker Meierhoff,  
Industry Professional



125 DRAWERS  
PULL-OUTS

- 60.000 - 80.000 load changes depending on load.
- This equates to approx. 11 to 15 times the amount of opening and closing performed in a day.



126 HINGED DOORS

- 60,000 - 80,000 load changes depending on load.
- This equates to approx. 15 times the amount of opening and closing performed in a day.



127 ROLL-UP FRONTS

- 60,000 load cycles.
- This equates to approx. 11 times the amount of opening and closing performed in a day.



## THE LATEST FROM THE WITCHES' KITCHEN

The kitchen is at the heart of life. And is thus expected to perform: it has to hold up to aggressive substances like citric acid or highly staining liquids. In order to test surfaces for their ability to withstand daily wear we subject them to chemical testing and abrade them with rough and sharp objects, and even simulate long-term wear on the handles tens of thousands of times. Only then does the surface of a nobilia kitchen really show what it can withstand.



### 128 CHEMICAL-RESISTANCE

During so-called agents testing, applied agents are left on the surface for a predetermined period of time, according to wear group.

For instance:  
acetone 10 seconds, vinegar  
1 hour, coffee 16 hours,  
olive oil 16 hours.

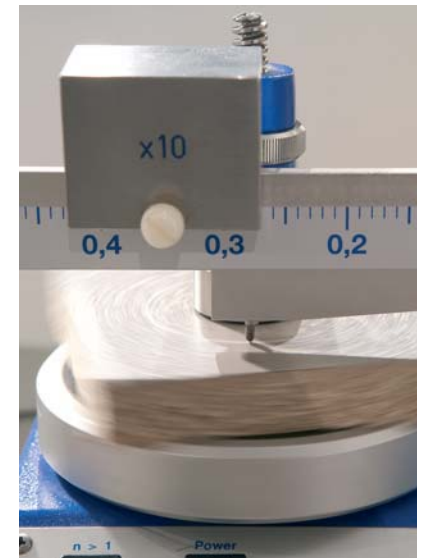

### 129 ABRASION TEST FURNITURE SURFACES

This test measures the abrasion resistance of the decorative surfaces. Continuous sanding with a defined applied weight and abrasive grit simulates wear of the surface.

### 130 SCRATCH TEST

A diamond point is pressed onto the rotating test specimen with increasing force. The scratches resulting on the test specimen are visually assessed with the viewing device.



### 131 CONDENSATION WATER CONSTANT CLIMATIC TEST

Components (e.g. painted attachment parts, metallic components) are kept in a water bath at a constant test room temperature of 40°C.

The constant humidity (100% relative humidity) created in the test chamber serves for testing the resistance of components to climatic influences / humidity.



With our tests and trials we have far exceeded the required DIN and DGM standards. This means, components that have passed the test also have an above-average service life. Thus, we give the buyer of a nobilia kitchen the security that they have purchased a superior quality kitchen.

Oliver Wessel,  
Director QC Laboratory



### 132 SALT SPRAY TEST

Metallic components such as handles are exposed to extremely aggressive corrosion through salt spray. The objective: even after this test the components cannot show any signs of corrosion.

### 133 ABRASION TEST HANDLES

A cowhide strip loaded with spherical weights is moved over the handle surface in the testing device. This test simulates the abrasivewear on a handle over a period of 15 years.

## STORAGE UNDER CLIMATIC STRESS

During the climate test we simulate various climatic influences. For instance, the conditions of a container transport over sea, installation of the kitchen in a tropical climate as well as long-term simulations and accelerated ageing tests. All furniture components are subjected to various climatic tests.

## ARTIFICIALLY ACCELERATED AGEING

In addition to the climate test, the climatic exposure test cabinet can also be used to simulate the ageing process. Just like in a time machine, we simulate changing climatic forces and allow the new components to age artificially. Here, 15 years pass in just 270 hours. The objective: high resistance even under extreme conditions.



### 134 CLIMATIC TEST

The climatic test incorporates extreme changes in temperature and humidity over multiple cycles in accordance with the respective DIN standards.



### 135 COLD CHECK

The paint-bonding properties are tested with extreme temperature fluctuations: first, at -20° C Siberian cold for 16 hours and then at the extreme heat of 50° C for 8 hours.



With a so-called cross-cut adhesion test we can determine to what degree the lacquer coating has reacted to the extreme temperatures.

## WE GET YOU ALL STEAMED UP!

Moisture, heat, cold! In the daily kitchen work cycle the individual components must withstand all external influences. In the water exposure test, for instance, we test the resistance and impermeability of carcase and front component edges to water vapour.

## TURN ON THE WATER!

Water is the worst enemy of kitchen furniture. A well-made carcase, worktop and front must be able to withstand daily wear over a long period of time. We test for the resistance and impermeability of edged materials with submersion in a water bath.



### 136 RESISTANCE TO WATER VAPOUR

Components are subjected to a so-called vapour deposition tower five times in a row for 30 minutes each time. Swelling or detachment of the edge is not permitted.



### 137 WATER BATH TEST

According to nobilia testing guidelines, the components stay for two hours with the test edge submerged in a water bath. Changes to the component such as swelling damage or tears are not permitted even after this period of time.

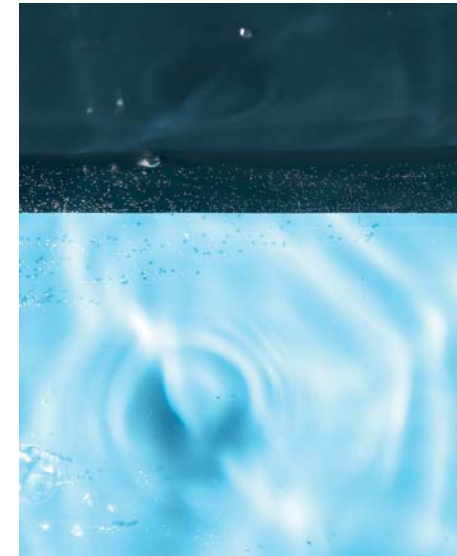

The test is performed in accordance with nobilia's own testing standard and is also performed as series-accompanying tests during production.

EVERY KITCHEN FRONT MUST BE ABLE TO WITHSTAND 10 YEARS WORTH OF SUN ON THE ISLAND OF SYLT!

We even test our furniture surfaces for this. Using a Xenon arc lamp in the laboratory we simulate the amount of UV irradiation that a kitchen would be subjected to over the years. This allows us to artificially age the surfaces. That way, we can accurately determine the degree of discolouration in the time elapsed and avoid such large deviations in the first place.



138 SUN TEST

The characteristics of the irradiated surface are compared with the characteristics of those surfaces which were covered.

- A grey scale in accordance with DIN EN 20105 is used for the assessment.
- The test procedure is described in DIN EN 15187.

COLOUR FIDELITY OF THE RANGE

In order to eliminate colour deviations from series production surfaces, we test our materials under different standard light types and compare these with specified colour standards (Metamerism Index). In this process we evaluate the surfaces in daylight, artificial light and fluorescent light.



139 STANDARD LIGHT TEST

The reliable evaluation of colour and degree of gloss is very important, for instance, when one is dealing with reorders from other batches. The colour accuracy must be ensured and the degree of gloss must always be the same.

DANGER, HOT!

How much heat can a worktop withstand? Anyone who has ever left a hot pot sitting on the worktop is familiar with this situation. For a while the worktop can withstand it, but at some point a burn ring forms. We test that here!



140 HEAT TEST  
WET AND DRY HEAT

We test the heat resistance of worktops in accordance with DIN 68930.

- Heat resistance to dry heat up to 180°C.
- Heat resistance to moist heat up to 100°C.

## NOBILIA SETS STANDARDS

As a provider operating worldwide, nobilia feels responsible for customers and employees, products and production processes. For this reason, the company submits itself to official testing by independent experts. We offer our trade partners and their customers certified reliability that our kitchens are of superior quality and are environmentally-consciously produced.

141

## THE FIRST ONE THERE

**DIN EN ISO 9001:2000 Certified Quality Management**  
ISO standards are standards that are valid in all of Europe and recognised worldwide. In accordance with DIN EN ISO 9001:2008 the quality management systems of a company are evaluated in their entirety. The central idea of quality management is to analyse customer requirements and to establish and monitor processes, in order to produce products in accordance with market demands. The certificate has market-strategic significance and guarantees the future of a reliable customer relationship. In 1994 nobilia was the very first kitchen furniture manufacturer in Germany to become certified. In March 2010 the QM certificate DIN EN ISO 9001:2008 was reconfirmed.



142

## IT IS OUR PLANET

**DIN EN ISO 14001:2005 Certified Environmental Management**  
The DIN EN ISO 14001 is the certification standard of environmental management systems recognised worldwide. Since 2007 nobilia has been successfully undergoing the environmental certification process in accordance with this ISO standard, which particularly emphasises environmental protection and conservation of natural resources. The assessment comprises the company environmental policies, its verifiable environmental goals and the company-wide



143

## OUR RESPONSIBILITY

environmental programme designed to achieve them. The ISO environmental standards require an environmental management system that regulates planning, implementation, controls and improvements within the framework of a continual improvement process. The certificate is an essential prerequisite for success in many markets. With it, nobilia offers their trade partners the reliability of a sustainable, certified environmental management. In April 2010 the QM certificate DIN EN ISO 14001:2008 was reconfirmed.



**PEFC/04-31-1281**  
Since July 2009 nobilia is the first kitchen manufacturer certified in accordance with PEFC (Programme for the Endorsement of Forest Certification Schemes). This certification documents nobilia's commitment to a livable environment and takes responsibility in handling precious wood resources. Because the wood materials we use come from sustainably managed forests and controlled sources. Forest certification provides the guarantee that the





144 THE GOLDEN M

wood products you purchase do not derive from questionable sources or over-exploitation, but rather originate from forests that are managed in harmony with nature. The purchase of a PEFC certified nobilia kitchen demonstrates the buyer's sense of responsibility for our environment.

Are you familiar with our film about PEFC?

You can find out more using the following link.  
[www.nobilia.de/#/unternehmen/pefc](http://www.nobilia.de/#/unternehmen/pefc)

**RAL Quality Seal 430**

This quality seal is awarded by the Deutschen Gütegemeinschaft Möbel e.V. (German furniture quality seal). The strict requirements of the DGM far surpass those of national and international standards and distinguish products of above-average quality.

Quality tested and approved furniture must be sturdy, safe, durable and well-made - and it cannot contain any ingredients deemed hazardous to health. Meticulous tests and strict controls ensure that furniture with the RAL quality seal adhere to the extensive criteria.

The German "Golden M" counts both nationally and internationally as one of the most distinguished quality certificates issued based on the most stringent criteria. For consumers it means certainty that a product is of first class quality and has been manufactured in an environmentally safe manner. The long-standing, intensive cooperation between DGM, the Deutschen Verbraucherzentrale (German consumer protection agency) and the Stiftung Warentest (German non-profit organisation for independent product testing) is an important basis of trust for the consumer.



145 PLAYING IT SAFE

**GS (Geprüfte Sicherheit) mark for tested safety**

This certificate is awarded by the LGA Nuremberg. The LGA belongs to the TÜV Rheinland Group (international service group) and is Europe's largest and most important furniture testing organisation. The GS mark for tested safety is a voluntary safety mark that has significance far beyond the borders of Germany. In the area of consumer protection

and occupational health and safety it is the guarantee that the safety-related requirements have been met and reviewed by an independent body such as the LGA and will also be regularly monitored. LGA quality certificates for furniture, furniture parts, components and accessories is an identifying feature for tested and controlled quality and product safety.





nobilia-Werke  
J. Stickling GmbH & Co. KG  
Waldstraße 53-57  
D-33415 Verl  
Fon +49 (0)5246-508-0  
Fax +49 (0)5246-508-96 999  
e-mail: info@nobilia.de  
www.nobilia.de

**nobilia**<sup>®</sup>

